

Vero

QUICK START GUIDE

HARDWARE / Mount. Cables. Connect.

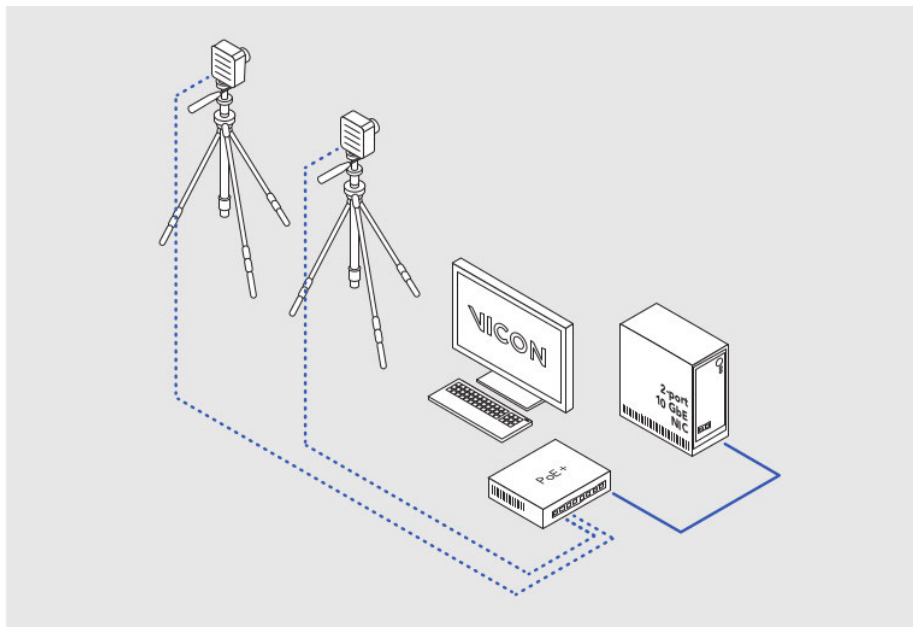

VOLUME / Visualize. Set up. Aim.

Lay out markers to define the desired volume.

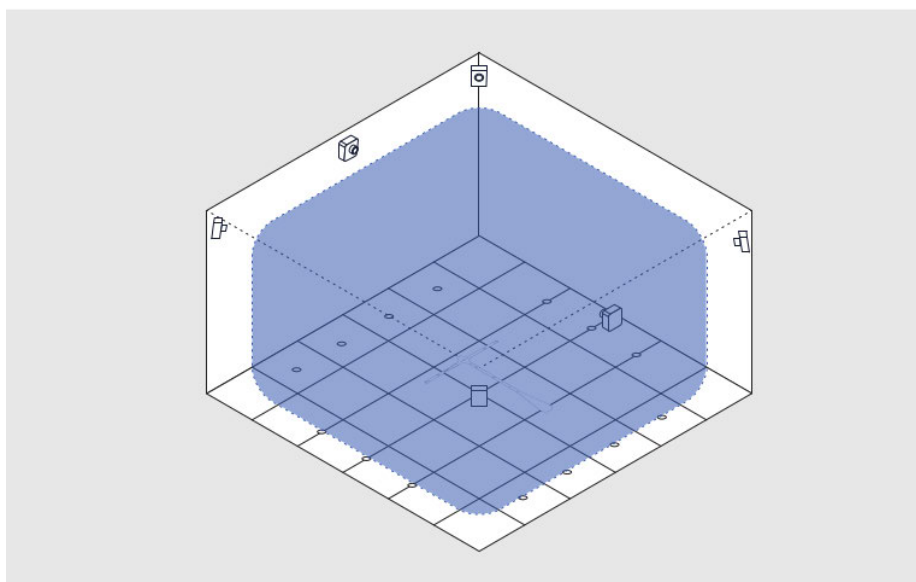

Point the cameras to provide roughly the required coverage. You will be able to refine camera aiming later, using your Vicon software.

For easy system setup, use the Vicon Control app



See vicon.com/products/software/vicon-control.

<https://accessgudid.nlm.nih.gov/B548VICONVEROSYSTEM0>



Vero QUICK START GUIDE

SOFTWARE / Download. Install. License.

- 1 www.vicon.com/downloads (supported from: Vicon Nexus 2.4, Vicon Tracker 3.3, Vicon Shogun 1.0)



- 2 Run SETUP.EXE.

- 3 Click Start, then Vicon Product Licensing.

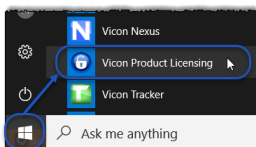

- 4 Request a license, save it to a suitable location and activate.

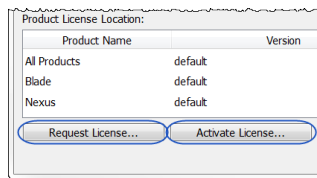

For details on installing and licensing, see your Vicon software documentation.

SYSTEM / Administrator. IP address. Adapter settings.

Important: Ensure you are logged on as Administrator.

- 1 Open the Network Connections window.

- 2 Right-click on the network port that connects to the PoE switch and click Properties.

- 3 In the Properties dialog box, click Configure and then the Advanced tab.

- 4 In the Settings list, ensure the values shown (in the images on the right and the first two columns on page 3) are selected, then click OK to close the dialog box.

- 5 Repeat step 2 to re-open the Properties dialog box.

- 6 Ensure only Internet Protocol Version 4 is checked (see page 3, last column) and click the Properties button.

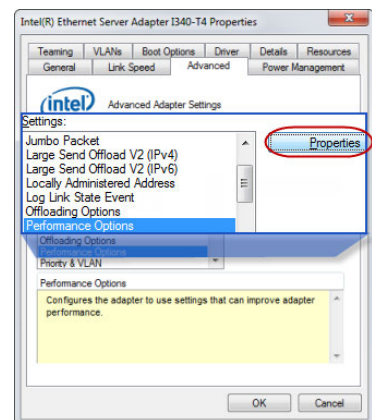
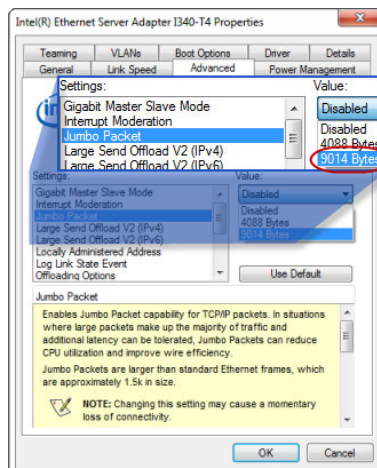
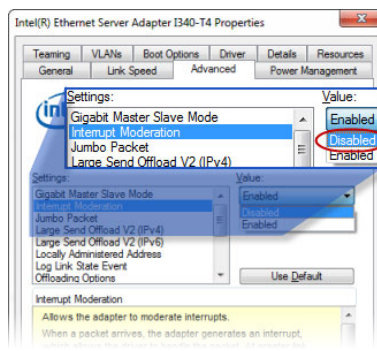

- 7 Specify the IP address 192.168.10.1 and subnet mask 255.255.255.0 (see page 3, last column) and click OK.

For detailed guidance on system setup, visit [Vicon system setup information](#) or download the Vicon PDF, *PC Setup for Vicon systems* from the same page.

SYSTEM (cont.) / Administrator. IP address. Adapter settings.

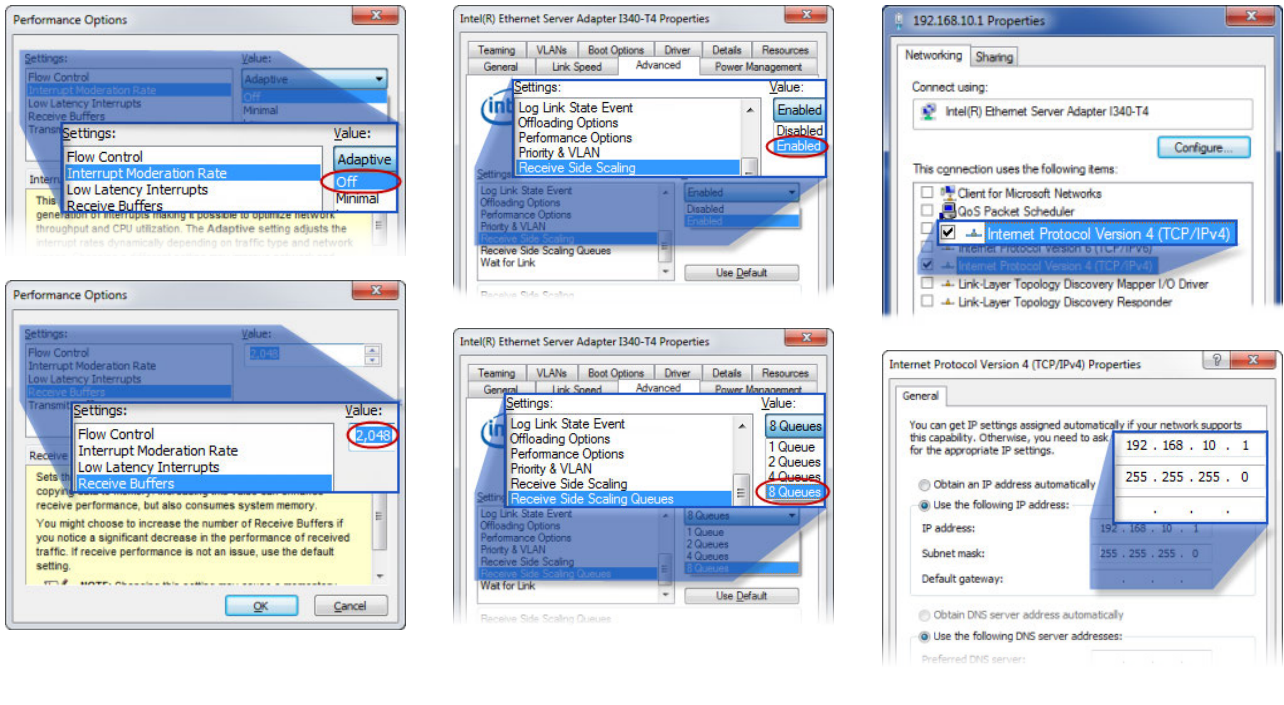

RUN / Start software. Unblock firewall. Connect.



1 After you start your Vicon software, ensure that it is not blocked by a firewall and that it shows the system is live.

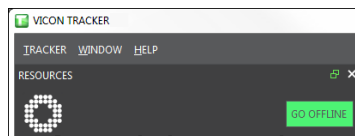
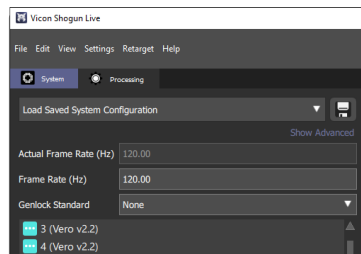
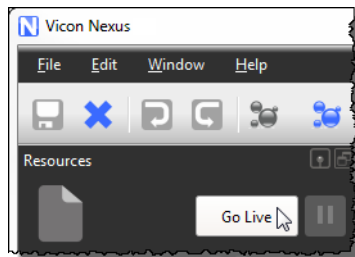
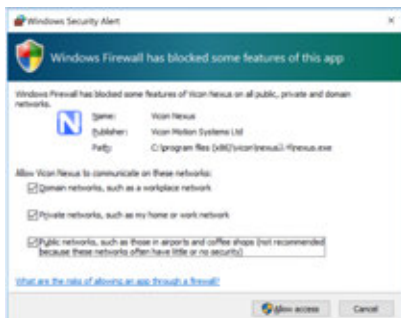

2 In the System Resources panel, Shift+click (or in Shogun, right-click in the System panel) to select all the cameras.

3 In the Properties pane, change Grayscale Mode to All.

4 In the System Resources panel (or in Shogun, System panel), select a camera.

5 In the View pane, change to Camera view.

You can now set the camera focus and aperture.

ADJUST / Zoom. Grayscale. Focus.

Focal length
W(ide)

Focal length
T(elephoto)

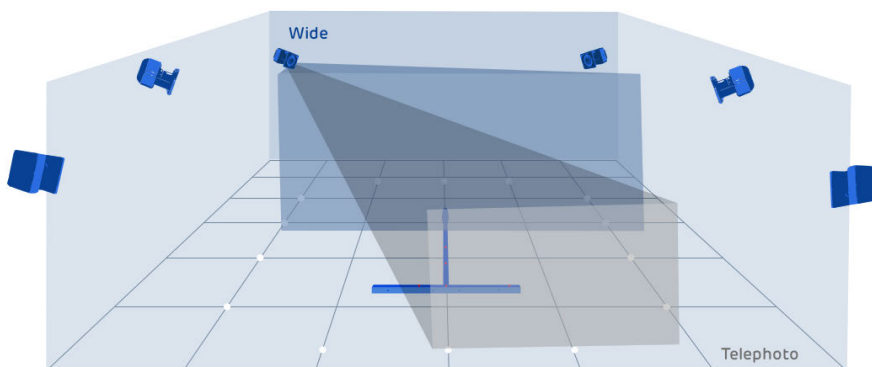

✗ Aperture too open:



✗ Aperture too closed:



✗ Image out-of-focus:

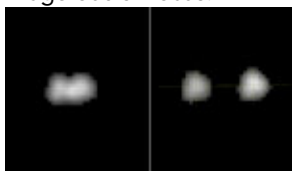

Correct marker image:

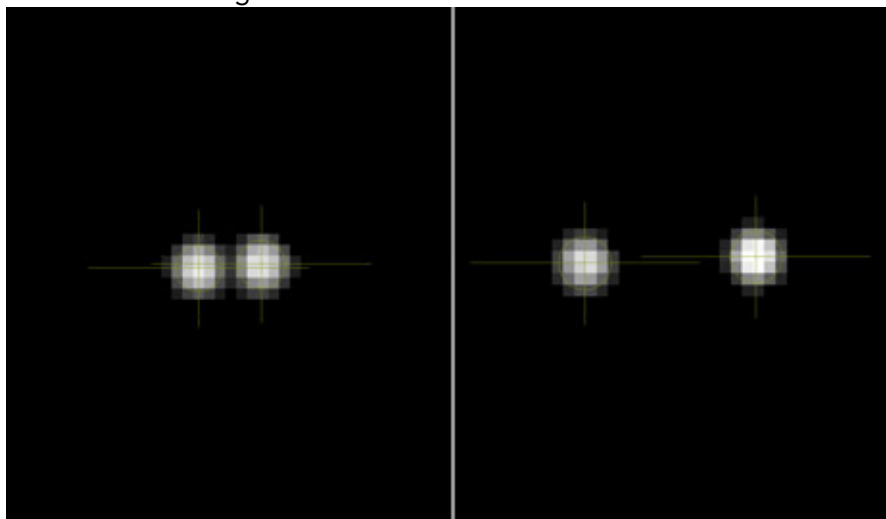

Markers touching

10 cm separation



The above example shows a correct marker image. The markers are not too small, with centers just off-white (not fully saturated) when viewed from the middle of the volume.



Warning
Under normal operation in elevated ambient conditions, the camera's heat sink temperature can exceed 56°C. During and after camera operation, do not touch the heat sink for longer than 1 second.



Important
Before you begin system calibration, select all cameras and change **Grayscale Mode** back to **Auto**. For more about calibration, see your Vicon software documentation.



About your Vicon camera packaging
The box in which your new Vero camera arrived has a foam insert that holds the camera. This insert prevents most damage that could be caused during shipping. We recommend that you retain this box as it provides the most convenient and safe way to ship your camera in future.

Vicon Vero regulatory and safety information

These topics provide information on how Vicon Vero complies with regulatory standards, including product recycling. The [certification](#) that Vero has achieved for meeting stated international standards.

- [Radio and television interference \(US and Canadian customers\)](#)
- [Environmental regulations \(EU customers\)](#)

Radio and television interference (US and Canadian customers)

This topic contains information concerning compliance with regulations of radio and television interference.

For United States of America customers

Federal Communications Commission (FCC) Part 15 Information

FC This equipment has been tested and found to comply with the limits for a Class A digital device, pursuant to Part 15 of the FCC Rules (CFR 47:Part 15:B:2013). These limits are designed to provide reasonable protection against harmful interference when the equipment is operated in a commercial environment. This equipment generates, uses, and can radiate radio frequency energy and, if not installed and used in accordance with the instruction manual, may cause harmful interference to radio communications. Operation of this equipment in a residential area is likely to cause harmful interference, in which case the user will be required to correct the interference at his own expense.

Properly shielded and grounded cables and connectors must be used in order to meet FCC emission limits. Vicon Motion Systems Ltd is not responsible for any radio or television interference caused by using other than recommended cables and connectors or by unauthorized changes or modifications to this equipment. Unauthorized changes or modifications could void the user's authority to operate the equipment.

This device complies with Part 15 of the FCC rules. Operation is subject to the following two conditions: (1) this device may not cause harmful interference, and (2) this device must accept any interference received, including interference that may cause undesired operation.

For Canadian customers

Conformity to the Canadian Interference-Causing Equipment Regulations

This Class A digital apparatus meets the requirements of the Canadian Interference-Causing Equipment Regulations ICES-003:2004.

Avis de conformité à la réglementation d'Industrie Canada

Cet appareil numérique de la classe A respecte toutes les exigences du Règlement sur le matériel brouilleur du Canada ICES-003:2004.

Environmental regulations (EU customers)

Restriction of the use of certain hazardous substances in electrical and electronic equipment – RoHS and recast (RoHS 2)

This equipment is fully RoHS- and RoHS 2- compliant. RoHS Directive 2002/95/EC provides that new electrical and electronic equipment put on the market for the first time from 1st July 2006 should not contain lead, cadmium, mercury, hexavalent chromium, polybrominated biphenyls (PBB), or polybrominated diphenyl ethers (PBDE). The European Union Directive [2011/65/EU](#) provides that new electrical and electronic equipment put on the market for the first time from 3rd January 2014 shall not contain more than permitted levels of lead, cadmium, mercury, hexavalent chromium, polybrominated biphenyls (PBB), or polybrominated diphenyl ethers (PBDE; PentaBDE, OctaBDE; DecaBDE), Mercury (Hg).

REACH Declaration of Conformity

Vicon Motion Systems Ltd is a manufacturer of electronic hardware. We are therefore considered a "downstream user" as far as the REACH document is concerned. Vicon Motion Systems Ltd is therefore not obligated to register with the European Agency for Chemicals 'ECHA'.

Products sold by Vicon Motion Systems Ltd are "articles" as defined in REACH (Article 3 Definitions). Moreover and under normal and reasonably foreseeable circumstances of application, the articles supplied shall not release any substance. For that, Vicon Motion Systems Ltd is neither obligatory for registration nor for the creation of material safety data sheets.

In order to assure our customers of the continual supply of reliable and safe products, we ensure that our suppliers fulfill all requirements regarding chemical substances and prepared materials.

Waste Electrical and Electronic Equipment (WEEE)

(Applicable in the European Union and other European countries with separate collection systems)



The use of the symbol as a marking on the equipment, accessories or literature indicates that this product and its electronic accessories (e.g. USB cable) may not be treated as household waste. By ensuring this product is disposed of correctly, you will help prevent potential negative consequences for the environment and human health, which could otherwise be caused by inappropriate waste handling of this product. Household users should contact either the retailer where they purchased this device, or their local government office, for details of where and how they can take these items for environmentally safe recycling. Business users should contact their supplier and check the terms and conditions of the purchasing contract. This device and its electronic accessories should not be mixed with other commercial waste for disposal.

EU Declaration of Conformity - Vicon Vero



Declaration of Conformity

Medical Devices Directive 93/42/EEC as amended by
EU Council Directive 2007/47/EC of 5th September 2007
Electromagnetic Compatibility to EMC Directive 2014/30/EU
Electrical Safety to Low Voltage Directive 2014/35/EU.

We, Vicon Motion Systems Limited
Unit 6, Oxford Industrial Park
Mead Road, Yarnton, Oxford, OX5 1QU
UNITED KINGDOM

declare that the optical motion cameras as part of a Vero System manufactured by VICON MOTION SYSTEMS LIMITED contribute to meet ANNEX V and VII Section 5 of the Medical Devices Directive 93/42/EEC in that the Quality Management System has been approved by Dare!! Services B.V., a notified body of the European Union (Reg No. 1912) for the manufacture and support of the aforementioned CLASS 1(m) Medical device. Product configurations and software options (Vicon Vero cameras), detail the product configurations and software options that conform to the metrological requirements of the Directive.

This declaration of conformity is issued under the sole responsibility of the manufacturer.

VICON MOTION SYSTEMS LIMITED has tested and demonstrated that all products of its own manufacture meet 2014/30/EU:

Electromagnetic Compatibility to:
EN60601-1-2:2007

General Requirements for Safety to:
EN 60601-1:2006 + A12:2014

Software Development, Conformity and Support
EN ISO 13485:2016
EN ISO 14971:2019
BS EN 62304:2006 + A1:2015, IEC 62304:2006/A1:2015

Thomas Shannon, TD PhD FIE (Aust), CPEng (Biomed.)
Director of Compliance

4th May 2021

Date Expiration 17th August 2023 (Article 120, EU 2017/745), subject to meeting the continued surveillance obligations, Section 4, Annex V. Certificate Number 20M00097CRT05 8th September, 2020.

Not for use in an operating theater, anesthetic gas environment, or oxygen-rich environments. Not for use where there is a risk of compromising the essential performance of medical electrical equipment. Not suitable for use in high magnetic flux, ionizing radiation, dust ingress, high vibration, sterile, or life- or safety-critical environments.

Note: The overall installed system classification is defined by the highest risk device connected, which may include the connection of approved third-party equipment such as electromyography apparatus by clients.

Product configurations and software options - Vicon Vicon Vero

This topic provides information relating to the EU Declaration of Conformity (Vicon Vero) .

Conformity of the Metrological Performance of CLASS 1 Products Manufactured in Accordance with Annex VII, Section 5 of the Medical Devices Directive 93/42/EEC of the 14th June 1993.

As amended by EU Council Directive 2007/47/EC of 5th September 2007.

We, Vicon Motion Systems Limited
Unit 6, Oxford Industrial Park
Mead Road, Yarnton, Oxford, OX5 1QU
UNITED KINGDOM

declare that the optical motion cameras within a VICON Vero System manufactured by VICON MOTION SYSTEMS LIMITED have been tested prior to shipment and meet the following metrological performance:

Measurement criteria

- Supporting software Nexus 2.10 or later, Tracker 3.8 or later, Shogun 1.4 or later.
- Using a minimum of four cameras, resolution of the distance between the centers of two static 14 mm spherical markers located within a volume no less than 4 m x 4 m x 1.5 m to within 1 mm Mean; 1 mm Standard Deviation; sample size no less than 1,000.

Vero

QUICK START GUIDE

Contact Vicon:

Denver, CO
Vicon Denver
7388 S. Revere Parkway
Suite 901, Centennial
CO 80112, USA
T: 303.799.8686
F: 303.799.8690
E: support@vicon.com

Los Angeles, CA
Vicon LA
3750 S. Robertson Boulevard
Suite 100, Culver City, Los Angeles
CA 90232, USA
T: 310.437.4499
E: support@vicon.com

Oxford, UK
Vicon Oxford
Unit 6, Oxford Industrial Park
Mead Rd, Yarnton, Oxford
OX5 1QU, United Kingdom
T: +44.1865.261800
E: support@vicon.com

© Copyright 2021 Vicon Motion Systems. All rights reserved.



Vicon trademarks